

Product Dimensions

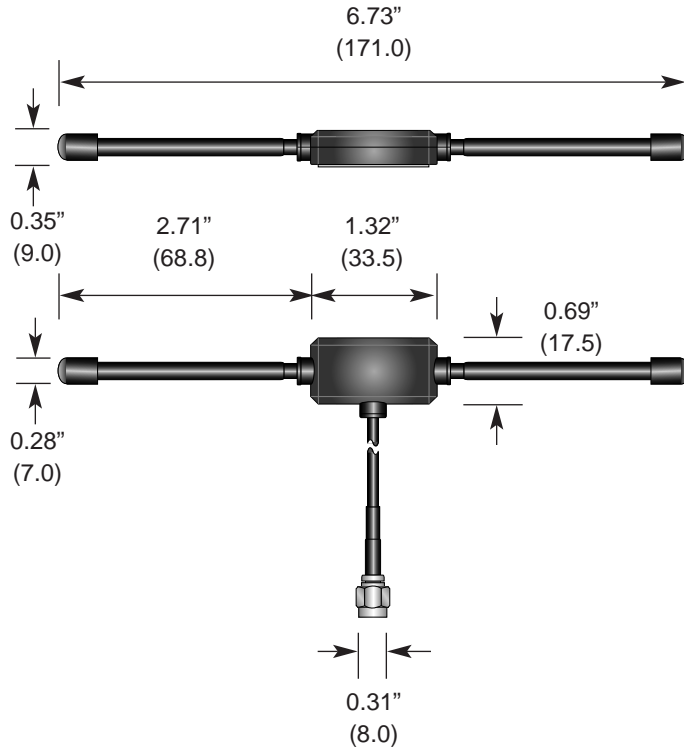

Description



MHW Series dipole antennas feature a durable, unobtrusive housing that sticks permanently with integral adhesive to flat, non-conductive surfaces such as windows, drywall, ceiling tiles, plastic, etc. The antennas are well suited to low-power devices, but are capable of operation at levels to 10 watts. The MHW is supplied with either 6.5 feet (2m) or 15 feet (4.6m) of RG-174 cable and attaches via a standard SMA or Part 15 compliant RP-SMA connector. Custom cable lengths and connectors are available for volume OEM customers.

Features

- Compact & unobtrusive
- Adhesive for flat surfaces
- Excellent performance
- Omni-directional pattern
- Very low VSWR
- Two flexible shafts
- Rugged & damage-resistant
- Standard SMA or Part 15 compliant RP-SMA connector

Electrical Specifications

- Center Freq. 433MHz
- Bandwidth 20MHz
- Wavelength 1/4-wave
- VSWR <1.5 typ. at center
- Impedance 50 ohms
- Connector RP-SMA or SMA
- Cable 78" or 180" RG-174 coax

Ordering Information

- ANT-433-MHW-RPS-L (RP-SMA connector, 180" coax)
- ANT-433-MHW-RPS-S (RP-SMA connector, 78" coax)
- ANT-433-MHW-SMA-L (SMA connector, 180" coax)
- ANT-433-MHW-SMA-S (SMA connector, 78" coax)

VSWR Graph

